

Byggmått böjar 45° DW VISION 50, tolerans +/- 5 mm.

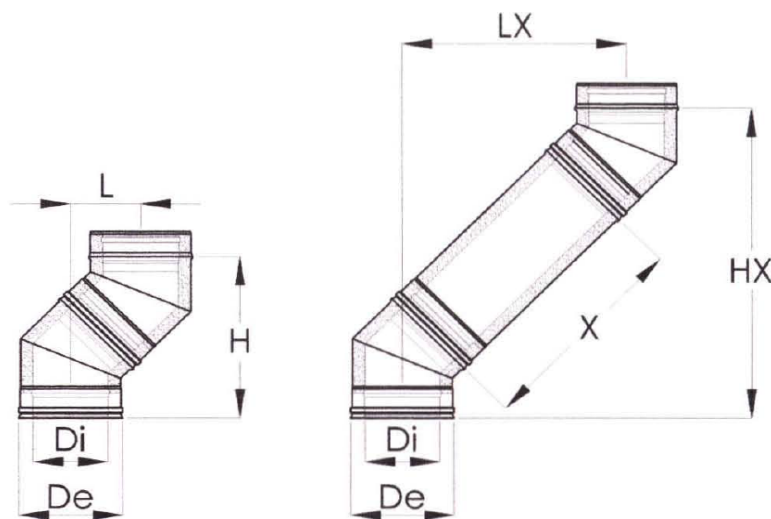

Di (mm)	De (mm)	L	H	X = skorstenslängd 940 mm		X = skorstenslängd 440 mm		X = skorstenslängd 190 mm	
				LX (mm)	HX (mm)	LX (mm)	HX (mm)	LX (mm)	HX (mm)
130	230	182	441	847	1105	493	752	317	575
150	250	188	454	852	1119	499	765	322	589
200	300	204	492	868	1157	515	803	338	626