

Byggmått böjar 15° DW VISION 50, tolerans +/- 5 mm.

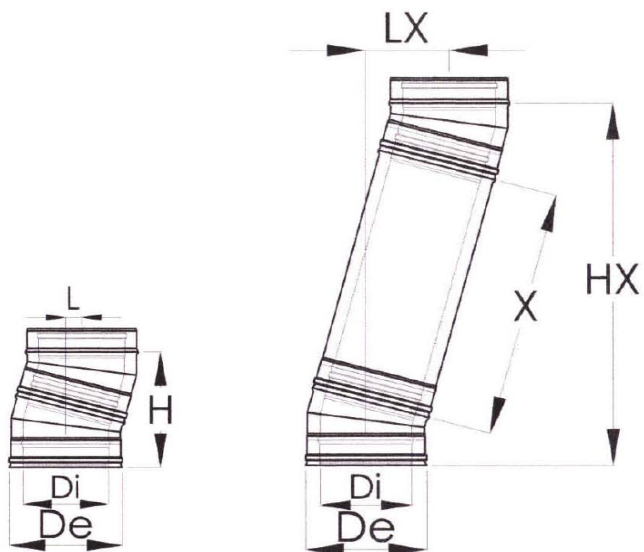

Di (mm)	De (mm)	L	H	X = skorstenslängd 940 mm		X = skorstenslängd 440 mm		X = skorstenslängd 190 mm	
				LX (mm)	HX (mm)	LX (mm)	HX (mm)	LX (mm)	HX (mm)
130	230	50	381	293	1289	164	806	99	565
150	250	51	385	294	1293	165	810	100	569
200	300	52	397	295	1305	166	822	101	581